



1. LÉKAŘSKÁ FAKULTA  
UNIVERZITY KARLOVY V PRAZE

VŠEOBECNÁ FAKULTNÍ  
NEMOCNICE V PRAZE



# HLA typizace celiakie aneb Vojta je Váš!

Markéta Jančíková

Ivana Janatková

Miroslav Hindoš



# Obsah

- Celiakie a genetika
- Metody stanovení HLA
- Diagnostika celiakie
- HLA alely spojené s celiakií
- Příklad: Vojta je Váš!
- Laboratorní statistika

# Celiakie

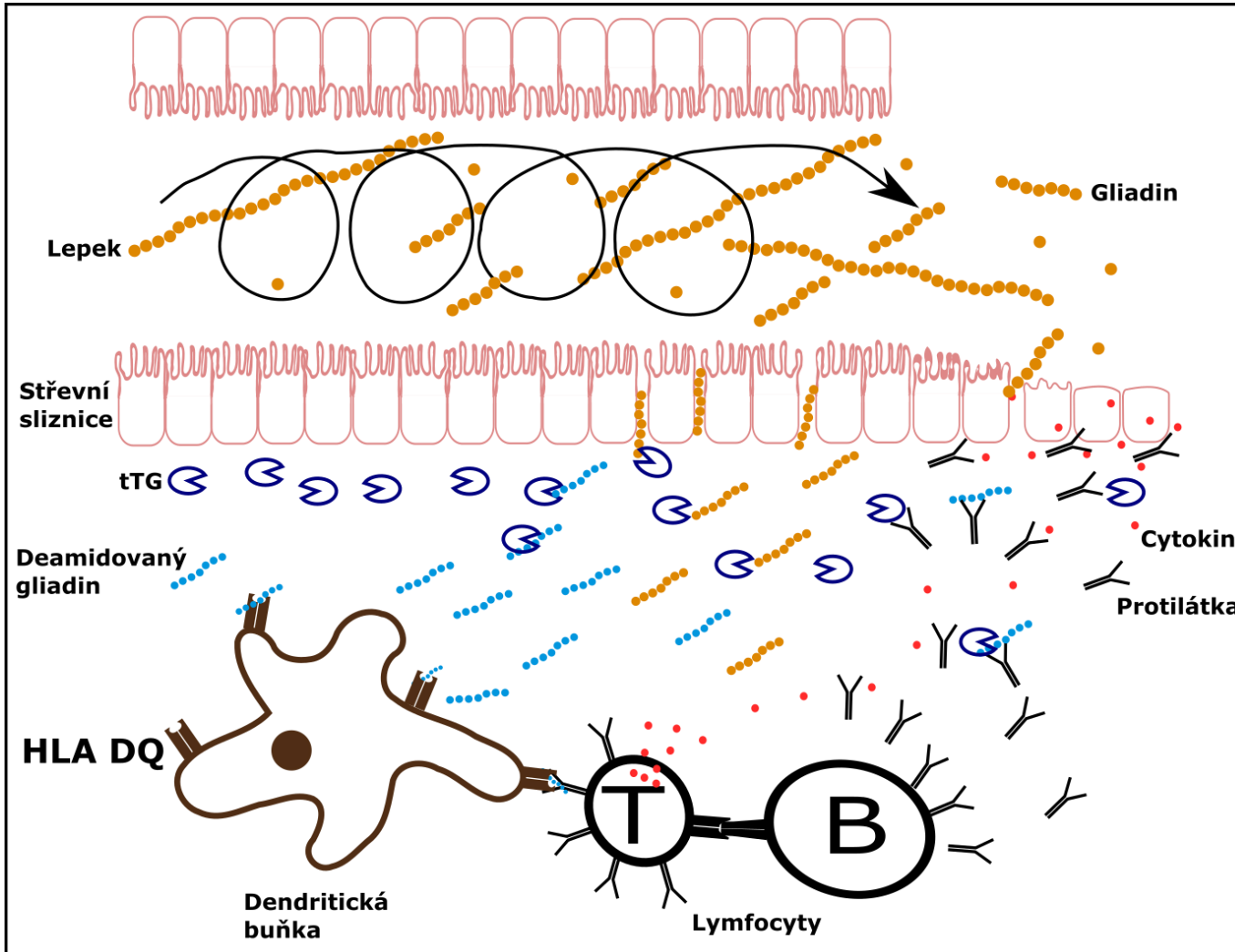

- Autoimunitní onemocnění
- Genetická predispozice
- Široké spektrum příznaků
- V dětském věku i dospělosti

# Metody stanovení HLA

- Izolace DNA
- PCR × Sekvenace
- Detekce
  - Elektroforesa
  - Hybridizace
    - na stripech
    - na čipu

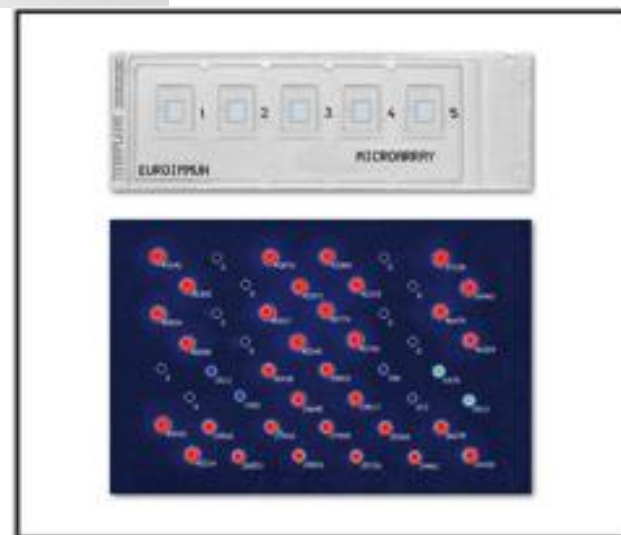
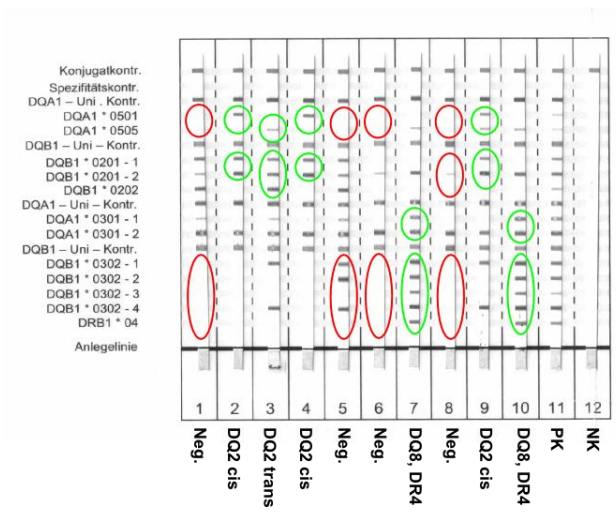





# The European Society for Paediatric Gastroenterology Hepatology and Nutrition (ESPGHAN)

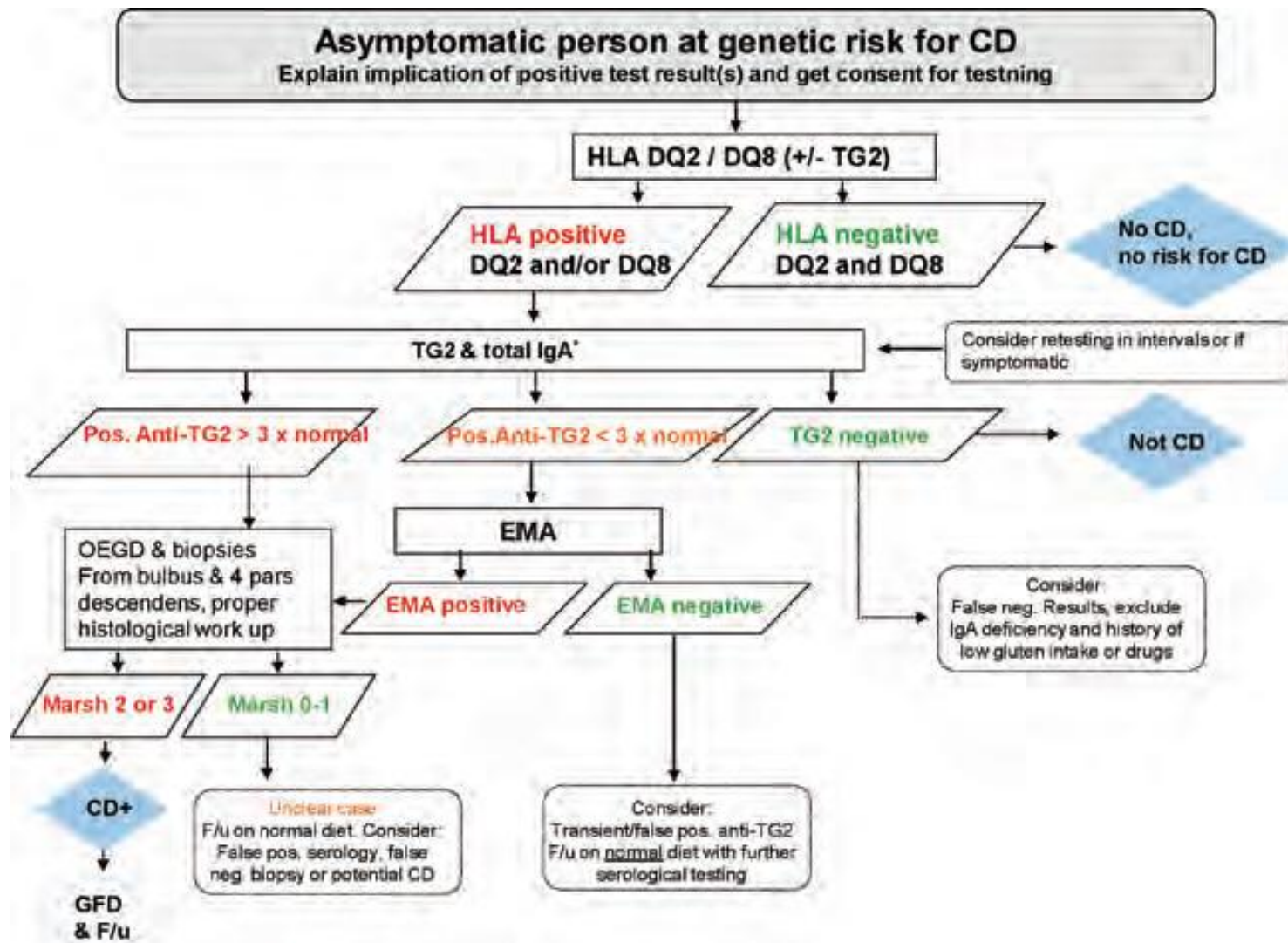

# Diagnóza celiakie

Protilátky proti tkáňové transglutaminase

Protilátky proti endomysiu-NIF

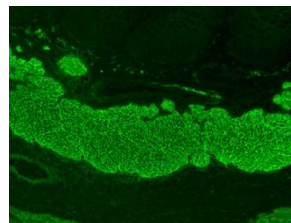
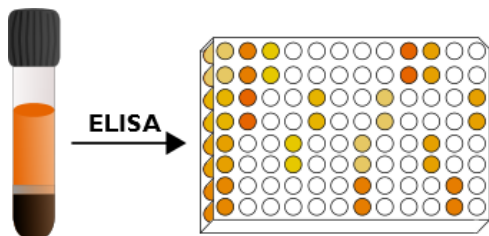

## Potvrzení diagnózy

Endoskopie



**NEBO?**

Genetické vyšetření HLA DQ



Konjugatkontr.  
Spezifitatskontr.  
DQA1 - Uni - Kontr.  
DQA1 \* 0501  
DQA1 \* 0505  
DOB1 - Uni - Kontr.  
DOB1 \* 0201 - 1  
DOB1 \* 0201 - 2  
DOB1 \* 0202  
DQA1 - Uni - Kontr.  
DQA1 \* 0301 - 1  
DQA1 \* 0301 - 2  
DOB1 - Uni - Kontr.  
DOB1 \* 0302 - 1  
DOB1 \* 0302 - 2  
DOB1 \* 0302 - 3  
DOB1 \* 0302 - 4  
DRB1 \* 04  
Anlegelinie

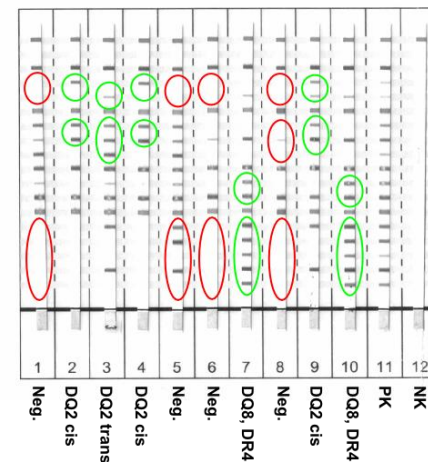

# HLA alely spojené s celiakií

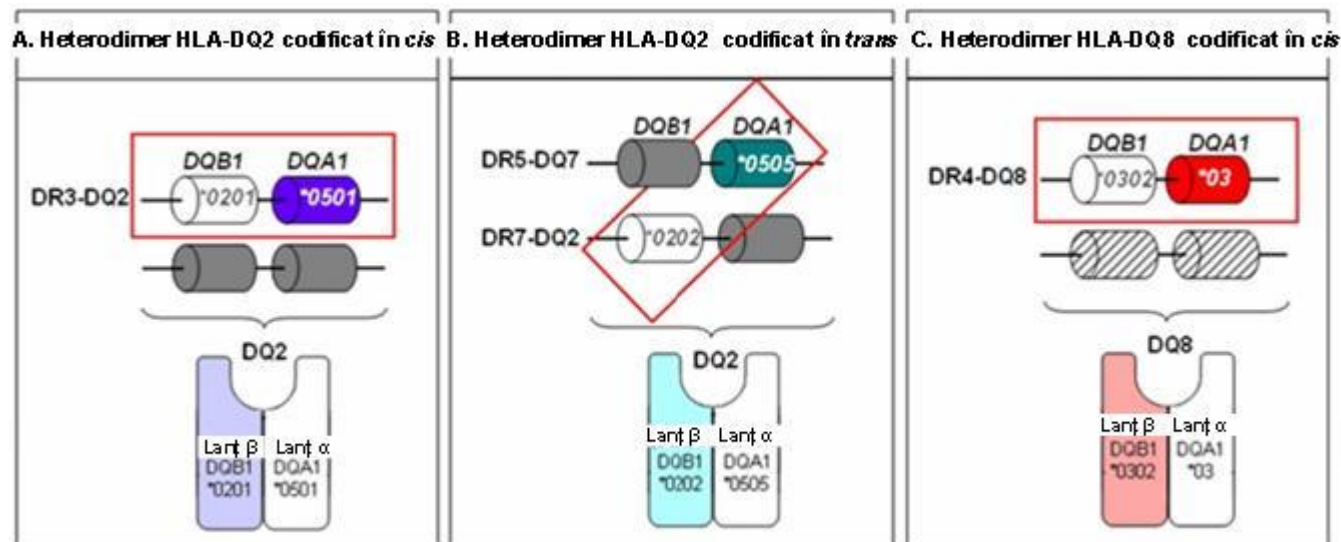
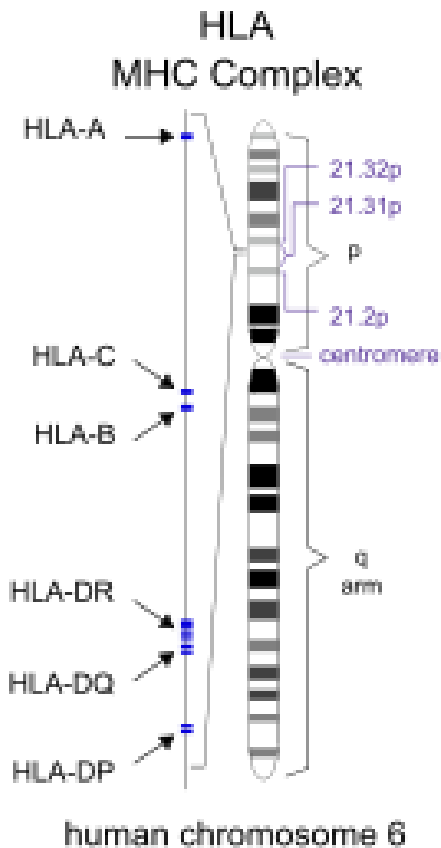

- Alespoň jednu z alel má 30% populace
- Alespoň jednu z alel má 90-99% pacientů trpících celiakií





# Rizika sledovaných alel



HLA status	Disease risk
DQ2.5 and DQ8	Very high
DQ2.5 (with a double dose of DQB1*02)	Very high
DQ8	High
DQ2.5 (with a single dose of DQB1*02)	High
DQ2.x (with a double dose of DQB1*02)	High
DQ2.x (with a single dose of DQB1*02)	Low
DQX.5	Extremely low
DQX.x	Extremely low





# Genetická loterie-Je Vojta Váš?

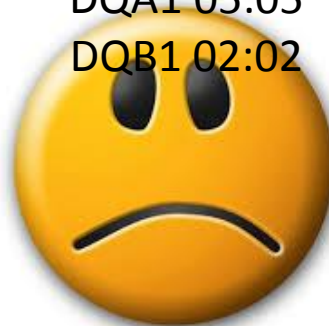
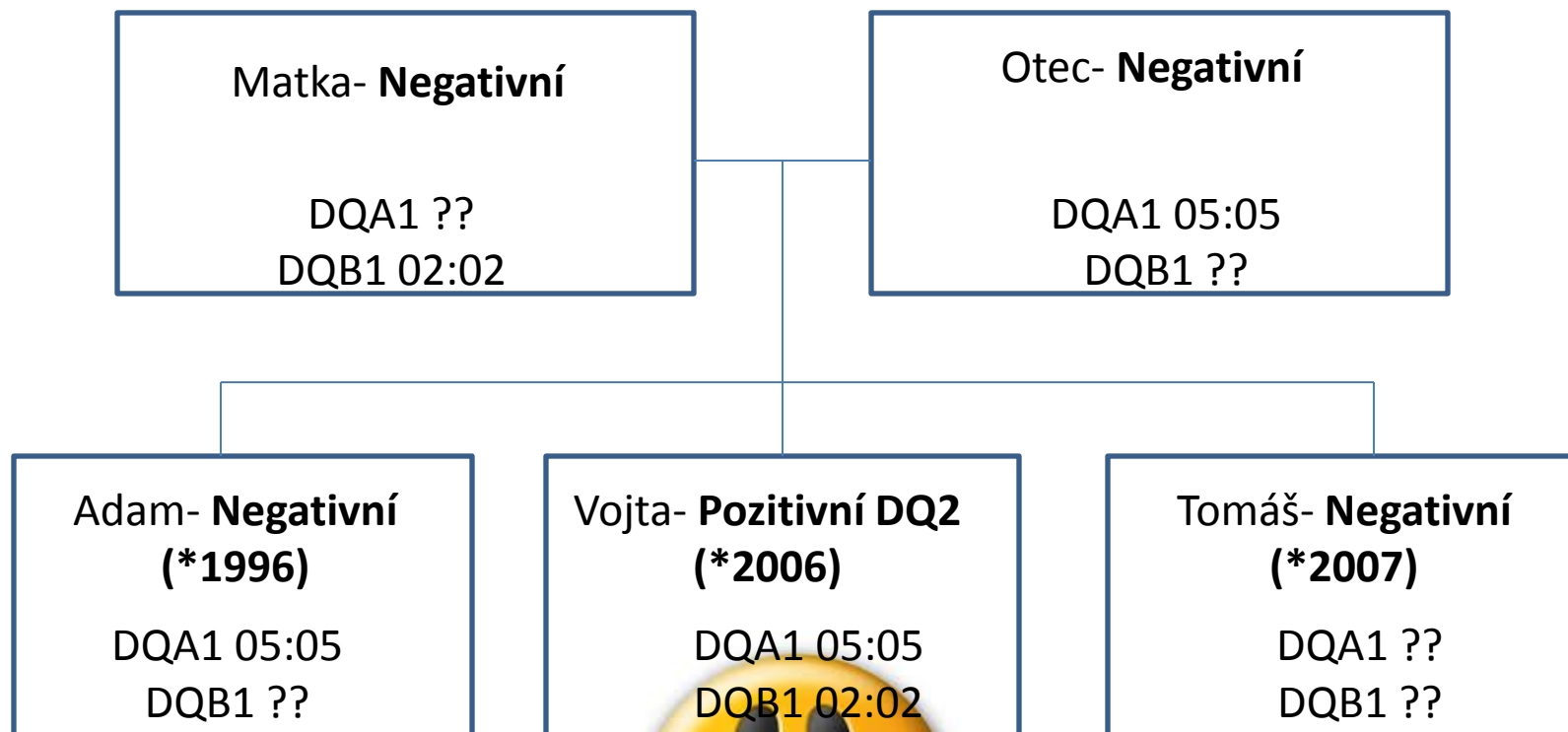

**Vojta je Váš !**



# Laboratorní statistika

hodnocení	Počet pacientů	procento
<b>Negativní</b>	324	<b>37%</b>
<b>Neprovedeno</b>	20	<b>2%</b>
<b>Pozitivní</b>	528	<b>61%</b>

**Celkem 872  
pacientů**

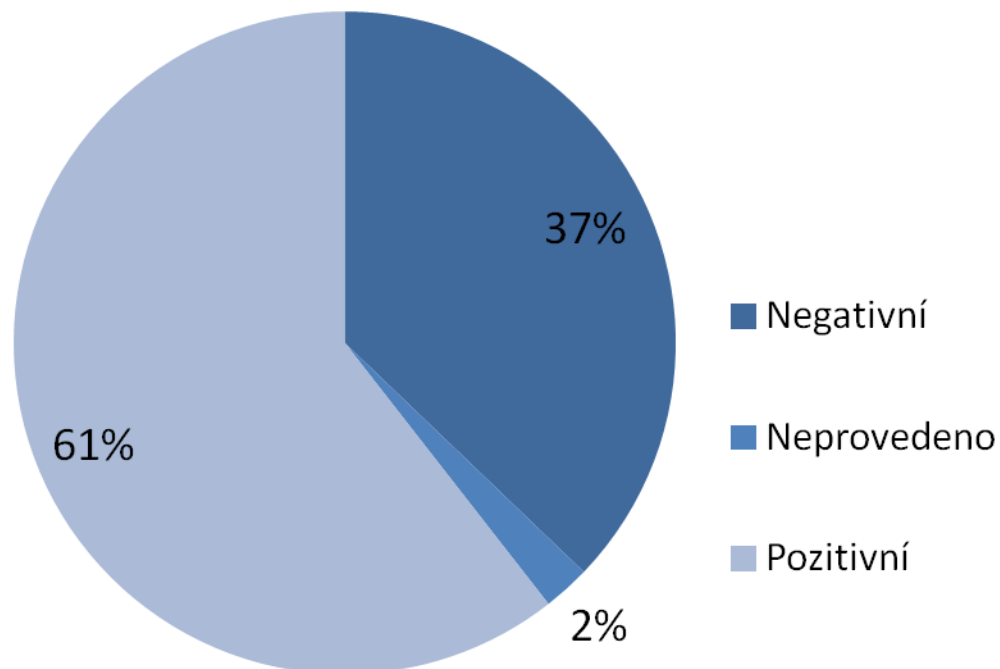



# Zastoupení DQ2 a DQ8

hodnocení	počet	procento
DQ2	327	70%
DQ8	102	22%
Obě	37	8%

**Celkem 446  
pacientů**

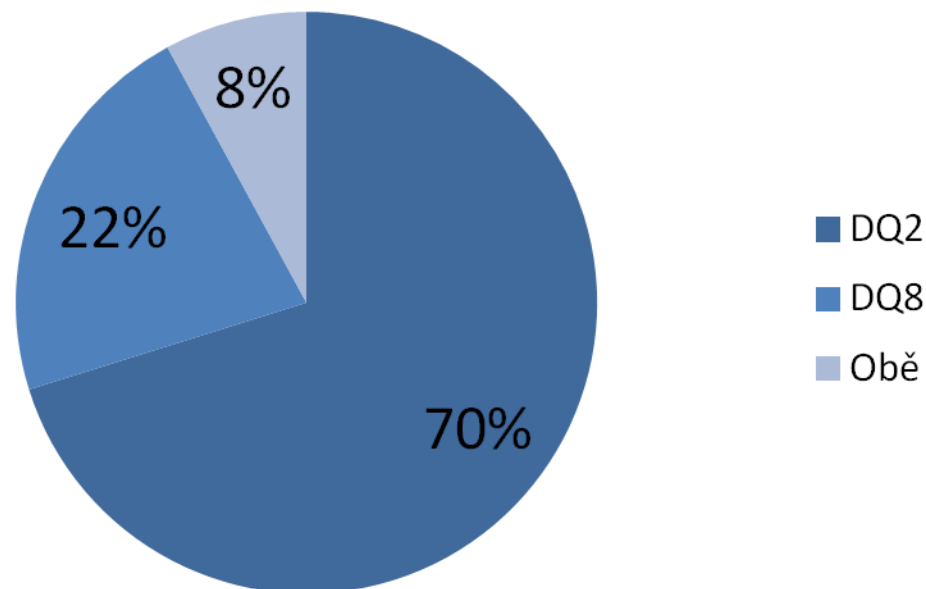

# Diagnosy spojené s vyšetřením

Pacienti s predispozicí (N=418)

Pacienti bez predispozice (N=209)

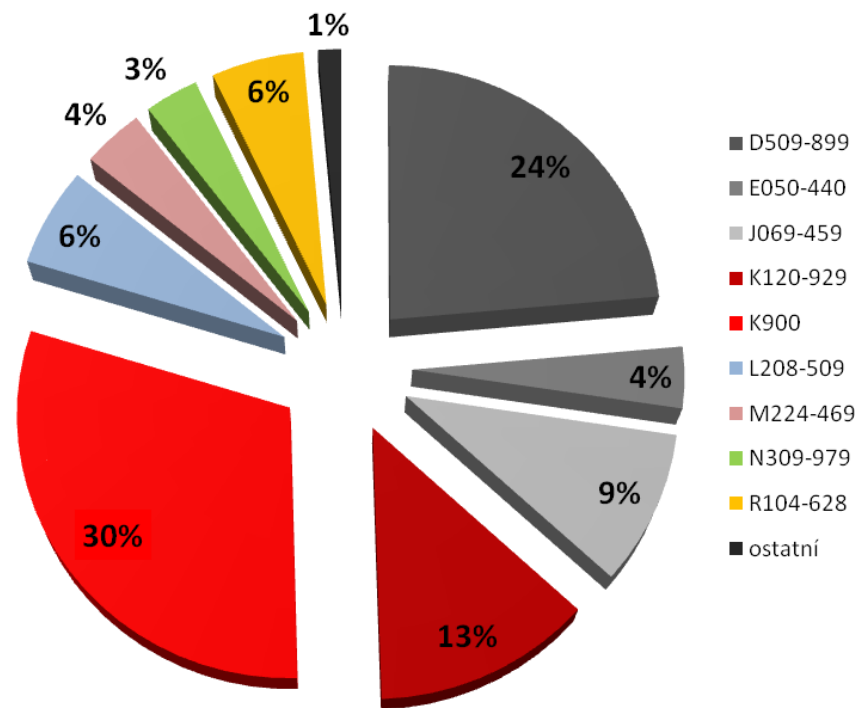
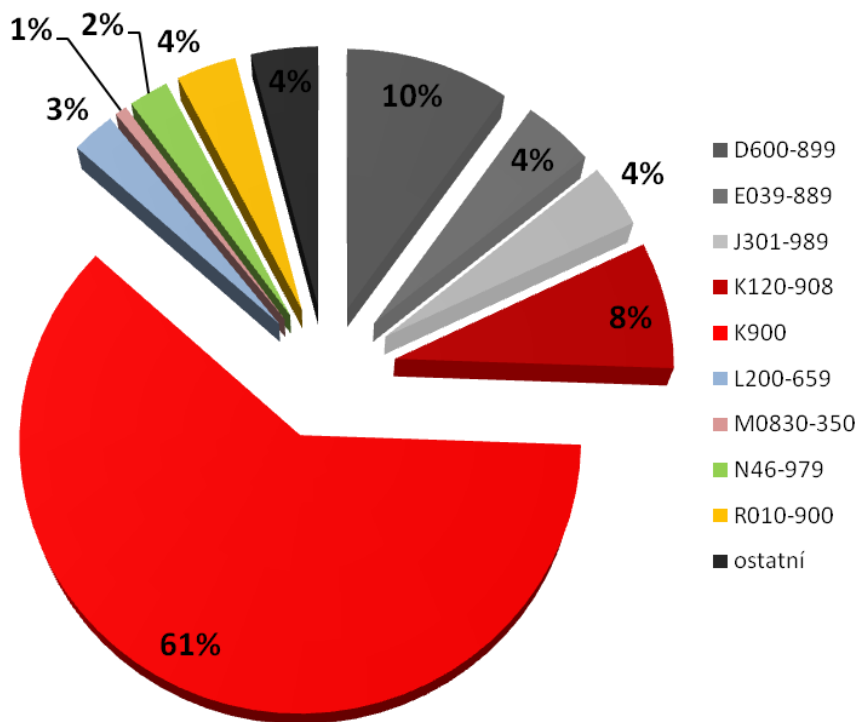





1. LÉKAŘSKÁ FAKULTA  
UNIVERZITY KARLOVY V PRAZE

VŠEOBECNÁ FAKULTNÍ  
NEMOCNICE V PRAZE



**DĚKUJI VÁM ZA POZORNOST**